

N1

Naturstein klassisch



Abbildung: N1
Naturstein (zweifarbige): Blanco Nacarado mit Negro Abanilla

Standard



Gesamtgewicht



Kamineinsatz

Lina 7363 h
NW-Leistung: 9 kW
Abgasstutzen: Ø 200 mm

Optional



A

Mehr Infos unter
camina-schmid.de

Zubehör



Naturstein

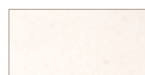
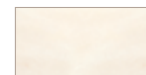
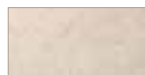
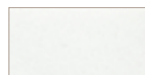
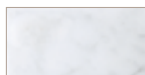

Frontansicht M 1:25

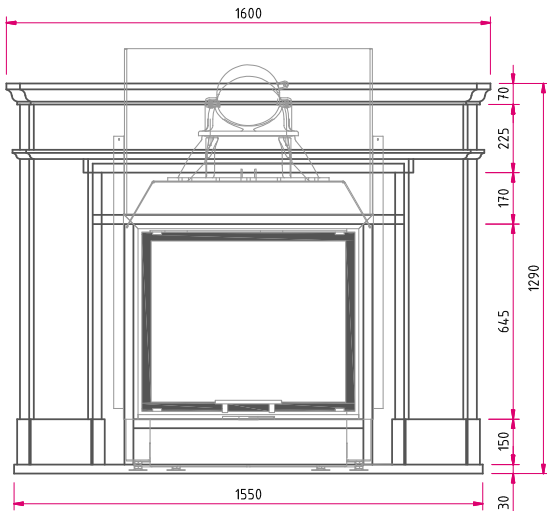

Seitenansicht M 1:25

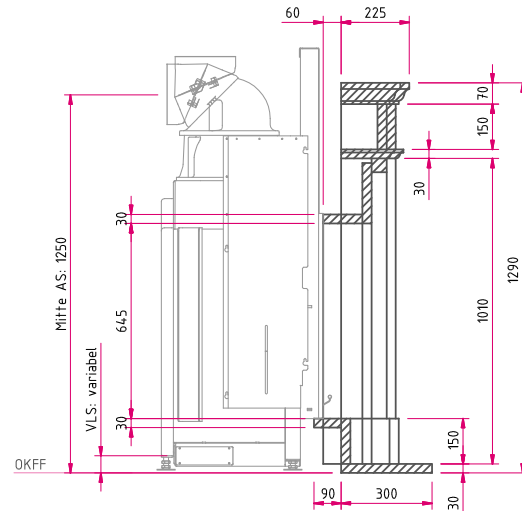

Hinweis: Mit **optionalem Zubehör** bitte die Angaben in den Preislisten beachten.
AS: Abgasstutzen, **VLS:** Verbrennungsluftstutzen, **OKFF:** Oberkante Fertigfußboden

Draufsicht M 1:25

